

dji OM 4

User Manual

V1.2 2020.10

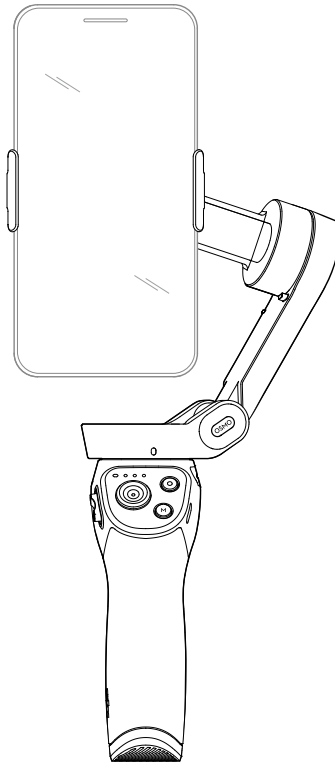

Searching for Keywords

Search for keywords such as “battery” and “install” to find a topic. If you are using Adobe Acrobat Reader to read this document, press Ctrl+F on Windows or Command+F on Mac to begin a search.

Navigating to a Topic

View a complete list of topics in the table of contents. Click on a topic to navigate to that section.

Printing this Document

This document supports high resolution printing.

Using this Manual

Legend

 Important

 Hints and Tips

Before Use

Read the following documents before using DJI OM 4:

1. Disclaimer and Safety Guidelines
2. Quick Start Guide
3. User Manual

It is recommend to watch all tutorial videos on the official DJI website (www.dji.com/om-4/tutorials) or in the DJI Mimo app. Read the disclaimer and safety guidelines and quick start guide before using for the first time. Refer to this user manual for more information.

Download the DJI Mimo App

Scan the QR code or search for "DJI Mimo" on the App Store or Google Play.



 The iOS version of DJI Mimo is compatible with iOS v11.0 and later. The Android version of DJI Mimo is compatible with Android v7.0 and later.

Contents

Using this Manual	2
Legend	2
Before Use	2
Download the DJI Mimo App	2
Introduction	4
Overview	4
Getting Started	5
Charging	5
Attaching the Phone	5
Using DJI OM 4	8
Button and Port Functions	8
Operating Mode	10
DJI Mimo App	11
Connecting to the DJI Mimo App	11
Camera View	12
Firmware Update	16
How to Update	16
Storage	16
Specifications	17

Introduction

Equipped with 3-axis stabilization, DJI OM 4 turns your mobile phone into a camera that can deliver stabilized and super-smooth image. The foldable design makes DJI OM 4 convenient to transport and store, while the brand new magnetic connection for the phone means it is even easier to use. Lightweight and ergonomic, DJI OM 4 puts seamlessly smooth video creation at your fingertips. Get creative with features such as ActiveTrack™ 3.0, Hyperlapse, Timelapse, DynamicZoom, Pano, and Story mode that are available through DJI Mimo.

Overview

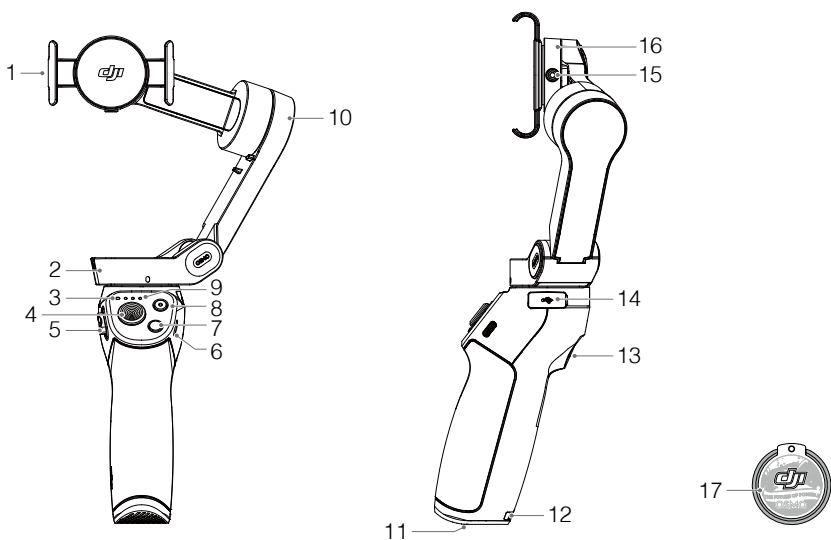

1. Magnetic Phone Clamp
2. Pan Motor
3. System Status Indicator
4. Joystick
5. Zoom Slider
6. Charging Port (USB-C)
7. Power/M Button
8. Shutter/Record Button
9. Battery Level Indicators

10. Tilt Motor
11. 1/4"-20 UNC Port
12. Lanyard Hole
13. Trigger
14. USB-A Port
15. M3x0.5 Screw Hole
16. Roll Motor
17. Magnetic Ring Holder

Getting Started

Charging

To charge DJI OM 4, connect a USB adapter (not included) to the charging port using the power cable (included). The battery is fully charged when the battery level indicators turn off.

Charging time: 2.5 hours (tested in the environment temperature of 25° C when using a 10W charger)

Max runtime: 15 hours (tested with the gimbal balanced and held steadily. This value should be taken as a reference only)

DJI OM 4 can be used as a power bank. Connect your mobile phone to the USB-A port. If DJI OM 4 is powered on, the mobile phone will begin to charge. If DJI OM 4 is powered off, press the M button once to start charging.

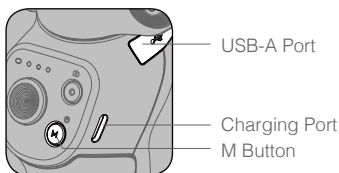

Attaching the Phone

1. The provided magnetic phone clamp and magnetic ring holder can be used to mount a phone to DJI OM 4.

Using the Magnetic Phone Clamp: attach the magnetic phone clamp in the center of the phone.

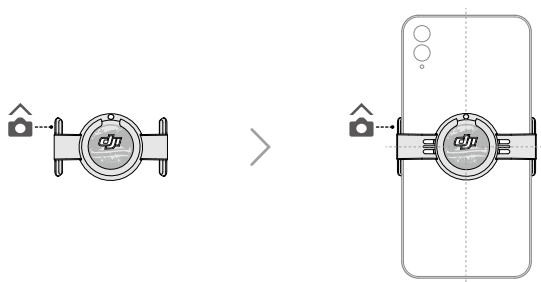

- ⚠ • Make sure the direction of the magnetic phone clamp is the same as shown and it is in the middle of the phone. Otherwise, the gimbal performance may be affected.
- Adjust the phone clamp and make sure it is as vertical like the phone.
- For optimal performance, use the provided riser pad if using a phone less than 7.5 mm thick or weighing less than 160 g.

Using the Magnetic Ring Holder:

- ⚠️ • Only attach the magnetic ring holder to phones that are supported by DJI OM 4. Refer to the DJI OM 4 Mobile Phone Compatibility List at www.dji.com/om-4 for more information.
- DO NOT attach the magnetic ring holder to a mobile phone case. Otherwise, the gimbal performance may be affected.
- Make sure no air is trapped between the sticker and the mobile phone. Otherwise, the mobile phone may fall off.



Follow the steps below to attach the magnetic ring holder to the center of the mobile phone.

- ① Use the wet wipes to clean the back of the mobile phone and use the dry wipes afterward. Attach the sticker to the center of the back of the mobile phone.
- ② Place the alignment guide on the back of the mobile phone. Adjust the position of the alignment guide to locate the center of the mobile phone.
- ③ Attach the magnetic ring holder to the back of the mobile phone. Make sure it is firmly attached.
- ④ Remove the alignment guide. Wait 12 hours before attaching the mobile phone to DJI OM 4 with the magnetic ring holder.

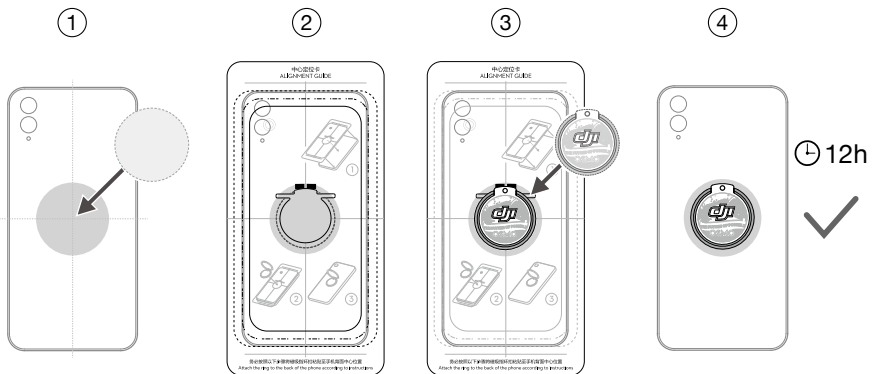

- Align the marks on the phone clamp or ring holder and the mounting plate. Attach the mobile phone to DJI OM 4.

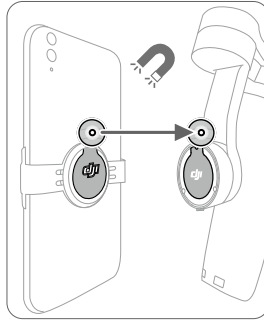

- Unfold DJI OM 4 and press and hold the M button to power on.

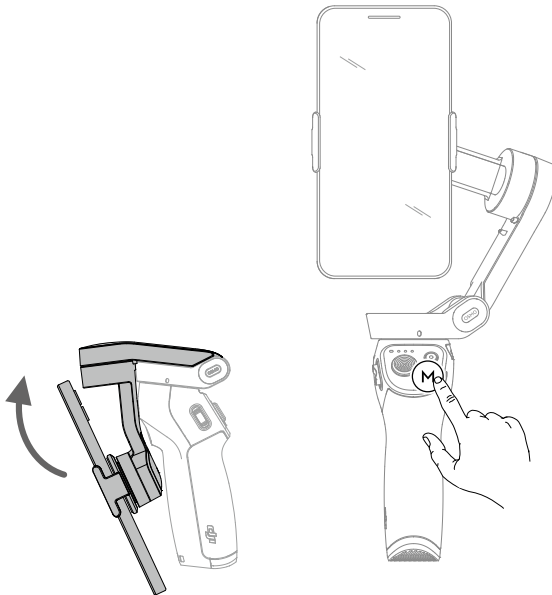

⚠ Mount your mobile phone before powering on DJI OM 4. If no mobile phone is detected, DJI OM 4 will vibrate and enter standby mode. To bring it out of standby mode, press any button after mounting the mobile phone.

Using DJI OM 4

After powering on, DJI OM 4 will enter follow mode by default. The gimbal converts joystick movements into smooth pan and tilt transitions, and reduces the impact of natural vibrations.

The mobile phone can be adjusted by hand as well.

Button and Port Functions

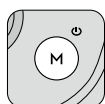

M Button

When Powered Off

Press once: check battery level.

Press and hold until it beeps once: power on.

When Powered On

Press once: switch between photo and video mode (this is the default setting and can be changed in DJI Mimo.)

Press twice: switch between landscape and portrait mode.

Press and hold until it beeps once: enter or exit standby mode.

Press and hold until it beeps twice: power off.

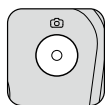

Shutter/Record Button

Press once to take a photo or start or stop recording. Press and hold for burst shooting when in photo mode.



Battery Level Indicators

Indicates the battery level of DJI OM 4.



System Status Indicator

Indicates the current status.

Blinking Pattern	Descriptions
Solid yellow	Bluetooth disconnected
Solid green	Bluetooth connected
Pulses yellow or green	Standby mode
Blinks red and green alternatively	Firmware updating/firmware update failed
Solid red	Gimbal abnormality (such as temperature is too low or high or battery is over discharged)



Joystick

Move vertically to tilt the mobile phone. Move horizontally to pan the mobile phone. The joystick control direction can be set in DJI Mimo.



Zoom Slider

Move the slider to the T position to enlarge the subject and move the slider to the W position to shrink. Push the slider once to change the zoom once. Push the slider continuously to change the zoom continuously.



Trigger

Press and hold to enter lock mode. In lock mode, the gimbal will not follow the handle movements. Release to exit lock mode.

Press once to start or stop ActiveTrack 3.0.

Press twice to recenter the gimbal. When using ActiveTrack 3.0, the gimbal will recenter to the center of the camera view.

Press three times to switch between front and back cameras.

Press once, and then press and hold to enter Sport mode. Release to exit. In Sport mode, the follow speed of the gimbal increases for capturing quick movements.



Charging Port (USB-C)

Charge DJI OM 4 by connecting a USB adapter to this port.

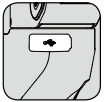

USB-A Port

The USB-A port can be used to charge mobile phones.



1/4"-20 UNC Port

The 1/4"-20 UNC port can be used to attach a tripod.



M3x0.5 Screw Hole

Used to mount counterweights. Counterweights should be used if a camera lens or microphone is mounted on the mobile phone. Make sure the total weight of these accessories is less than 290 g.



Lanyard Hole

The lanyard hole can be used to attach a wrist strap.

Combination Operation

The Bluetooth connection can be reset if DJI OM 4 cannot be connected or found. Press the M button, shutter button, and trigger simultaneously to reset the Bluetooth connection. The Bluetooth connection is reset successfully when the system status indicator turns from green to yellow. Search DJI OM 4 and reconnect.



DJI OM 4 will be powered off automatically if there is no operation for 10 minutes in standby mode.

Operating Mode

The figures below depict the operation modes when using OM 4 in landscape mode. The same operation modes apply when used in portrait mode.

Upright Mode

Upright mode can be used without any further user input. In this mode, press the M button twice quickly to center the mobile phone.

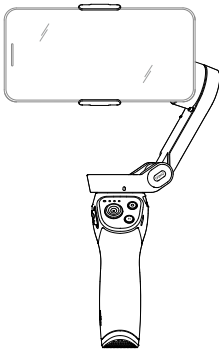

Underslung Mode

Hold DJI OM 4 upside down to enter Underslung mode, in which the mobile phone can easily capture images from a lower position.

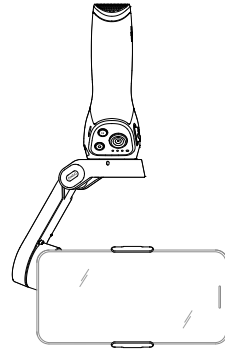

Side Grip Mode

Rotate DJI OM 4 to the right or left by 90° to go from Upright to Side Grip mode.

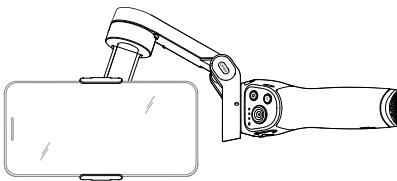

Low Position Mode

Press and hold the trigger, and then tilt DJI OM 4 forward to enter Low Position mode. The tilt angle is enlarged, making it more suitable to shoot from a low position.

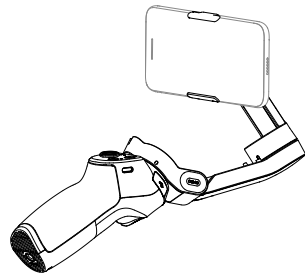

DJI Mimo App

Watch a live HD video feed on your mobile phone screen through the DJI Mimo app. The app also allows you to use Hyperlapse, Timelapse, ActiveTrack 3.0, DynamicZoom, Pano, and Story mode, or configure camera and gimbal settings in just a few taps.

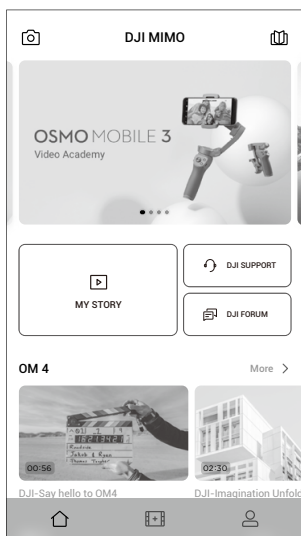

 **Camera View:** tap to connect to DJI OM 4. Once connected, DJI Mimo enters camera view.

 **Academy:** tap to watch tutorials and view manuals.

 **My Story:** provides several templates to edit photos or videos.

 **Home:** tap to return to the home screen.

 **Edit:** tap to edit photos or videos from DJI OM 4 or import and edit from a mobile device.

 **Profile:** register or log in to a DJI account. View works and settings, check likes and followers, send messages to other users, and connect with the DJI Store.

Connecting to the DJI Mimo App

1. Power on DJI OM 4.
2. Enable Bluetooth on the mobile phone and connect to the device with an OM 4 prefix name in DJI Mimo.
3. When using DJI Mimo for the first time, it is required to activate DJI OM 4 using DJI Mimo. Follow the instructions to activate. Register or log in to a DJI account when activating DJI OM 4. Make sure you are connected to the internet during the entire process.
4. Enter camera view after activation is complete.

 When connected via Bluetooth, DJI OM 4 is able to control the camera of the mobile phone without DJI Mimo. Refer to the Mobile Phone Compatibility List for details.

Camera View

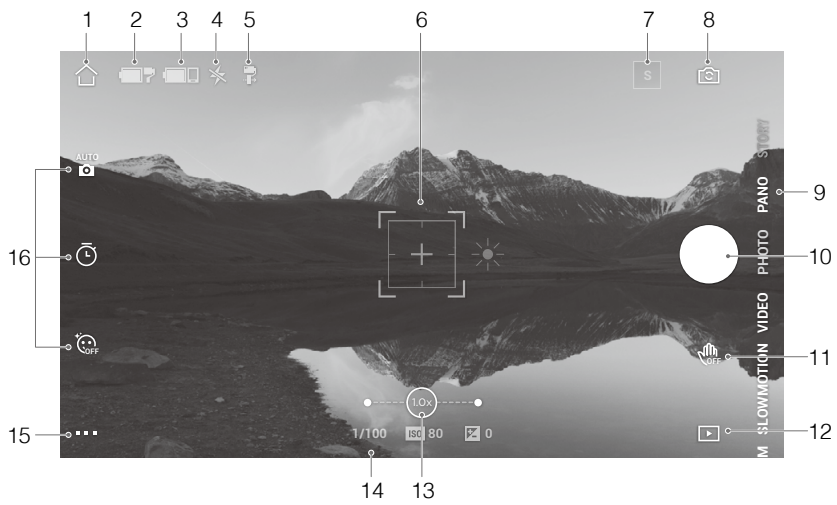

1. Home
🏠 : Tap to return to the home screen.
2. Gimbal Battery Level
🔋 : Displays the current battery level of the gimbal.
3. Mobile Phone Battery Level
🔋 : Displays the current battery level of the mobile phone.
4. Flash
⚡ : Displays the flash status.
5. Gimbal Mode
📷 : Displays the current gimbal mode: Follow, Tilt Locked, FPV, or SpinShot.
6. ActiveTrack Select Box
👤 : ActiveTrack 3.0 has been optimized for tracking human subjects with a head and shoulder model along with face detection using deep learning algorithms. The subject will remain in the center of the camera view by default. The camera view can be adjusted manually. There are three ways to use ActiveTrack 3.0:
 - a. Drag a box on the screen in the camera view in DJI Mimo. A green box around the subject indicates ActiveTrack 3.0 is successfully enabled. Tap the X icon on the top corner to stop tracking.
 - b. Enable Gesture Control in DJI Mimo and perform a palm or V gesture for one to two

seconds when facing the camera. The back camera will detect the nearest head and shoulders and start to track the subject. The front camera will detect the nearest face and start to track the subject.

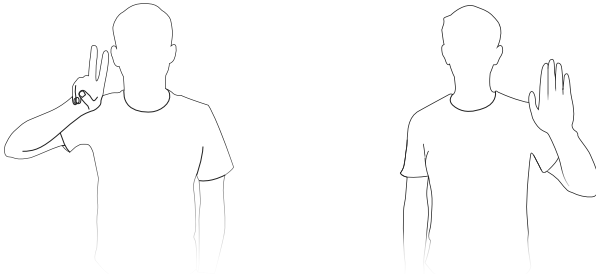

The differences between the head and shoulder tracking and face tracking are that head and shoulder tracking supports 360° tracking while face tracking does not. Also, the detection range of the cameras are different. The detection range between the back camera and the gesture is 0.5 to 4 m, and the distance between the front camera and the gesture is 0.5 to 2 m. Note that ActiveTrack 3.0 may consume more power and cause the temperature of the mobile phone to increase.

- c. Press the trigger once to start or stop ActiveTrack 3.0. When using ActiveTrack 3.0, move the joystick to adjust the camera view. Perform a palm or V gesture to stop recording.

7. Story Mode

 : Story mode provides several templates for recording video. When you are finished shooting, a video will be generated automatically according to the selected template.

8. Front/Back Camera Switch

 : Tap to switch between the front and back cameras of your mobile phone.

9. Shooting Modes

Scroll to select the shooting mode.

Hyperlapse: enable to shoot a Timelapse photo while moving the mobile phone. Tap the shutter button to begin.

Timelapse: there are two types of Timelapse, Position and Path. After selecting the Timelapse, tap the settings at the top of the screen. For Position Timelapse, set the interval and duration time and start to shoot. For Path Timelapse, up to four positions can be selected, and the gimbal will travel through the positions in order.

DynamicZoom: choose from Move Out and Move In mode. After selecting a mode, drag a box to select a subject, and tap the shutter button to start shooting.

Slow Motion: tap to shoot video at 8x slow motion.

Video: tap to shoot a normal video.

Photos: tap to take a single shot photo. Press and hold for burst shooting.

Pano: tap to take a 3x3, 240°, or CloneMe panorama photo.

Story: provides several templates for recording video.

10. Shutter Button

 : Tap to take a photo or to start or stop recording video.

11. Gesture Control Switch

 : Tap to access Gesture Control settings.



12. Playback

 : Tap to preview photos and videos.

13. Zoom

 : Place two fingers on the screen and move them apart to zoom in or move them together to zoom out.

14. Shooting Parameters

 **1/100**  **ISO 80**  **0** : Displays the shutter speed, ISO, and EV values (for iOS only).

15. Settings ■ ■ ■

 : Camera Settings

Note that the flash, white balance, and grid settings are only available when using the back camera. Selfie Flip is only available when using the front camera in photo mode.

 : Gimbal Settings

Gimbal Mode:

- a. Follow: pan and tilt axes follow.
- b. Tilt Locked: only the pan axis follows.
- c. FPV: pan, tilt, and roll axes follow.
- d. SpinShot: pan, tilt, and roll axes follow. The joystick can be used to control the roll axis rotation.

Sport Mode Switch: tap to enable or disable Sport mode. In Sport Mode, the follow speed of the gimbal increases greatly. It is suitable for shooting in scenarios where subjects move suddenly and at fast speeds.

Zoom Speed: tap to set the zoom speed when using the zoom slider.

Joystick Speed: tap to set the maximum speed when controlling the joystick. There are Fast, Medium, and Slow options.

Joystick Control Direction: choose from Free and Horiz/Vert. Free enables the gimbal to be controlled in horizontal and vertical direction simultaneously. Horiz/Vert enables the gimbal to be controlled in a horizontal or vertical direction.

Invert Pan Control: after enabling this feature, the pan axis movement direction is the reverse of the previous direction.

Invert Tilt Control: after enabling this feature, the tilt axis movement direction is the reverse of the previous direction.

Press M Button: switch between photo and video mode or enter/exit the quick menu. The function can be set by the user.

Gimbal Auto Calibration: reduces drift caused by nearby magnetic interference or human error. Before calibrating, place DJI OM 4 on a flat surface using a tripod. Do not touch the gimbal during calibration.

Horizontal Gimbal Adjustment: make sure the magnetic phone clamp is level before adjusting the gimbal.

: General Settings

Includes information such as Device Management, Device Name, Firmware Version, and Serial Number.

16. Shooting Parameters Settings

Shooting Modes	Settings
Hyperlapse	Resolution and FPS, Speed, ISO, Shutter, and EV
Timelapse	Resolution and FPS, Video Frame Rate, ISO, Shutter, and EV
Dynamic Zoom	Glamour Effects, Video Frame Rate, ISO, Shutter, and EV
Slow Motion	ISO, Shutter, and EV
Video	Glamour Effects, Video Frame Rate, ISO, Shutter, and EV
Photos	Glamour Effects, Count Down, ISO, Shutter, and EV
Pano	3x3, 240°, and CloneMe Pano, Count Down, ISO, Shutter, and EV

-  • FPS, ISO, Shutter, and EV settings are only available for iOS devices.
- When enabling Glamour Effects, the max video resolution is 1080p.
- Shooting parameter settings vary depending on the model of the mobile phone. Refer to the Mobile Phone Compatibility List (www.dji.com/om-4/downloads) for more information.

Firmware Update

Use DJI Mimo to update the DJI OM 4 firmware. It takes approximately three minutes to complete an update.

How to Update

Before starting an update, make sure that the battery level is at least 15% (at least two battery level indicators illuminated). Connect DJI OM 4 to your mobile device and launch DJI Mimo. You will be prompted if a new firmware update is available. To start updating, connect the mobile device to the internet and follow the on-screen instructions.

Do not exit DJI Mimo while updating the firmware. Pay attention to on-screen prompts. The system status indicator will blink green and red alternatively and become solid green once the firmware update has completed successfully.

If an update is unsuccessful, restart DJI OM 4 and DJI Mimo, reconnect the Bluetooth, and retry.

Storage

DJI OM 4 is designed to be folded for easier storage and transportation. Make sure to fold DJI OM 4 when it is powered off.

Rotate the pan and tilt axis to align with the marks on the gimbal and fold DJI OM 4. Note that the hole on the pan motor should be matched with the marker on the arm. DJI OM 4 will enter storage mode and can be folded after powering off.

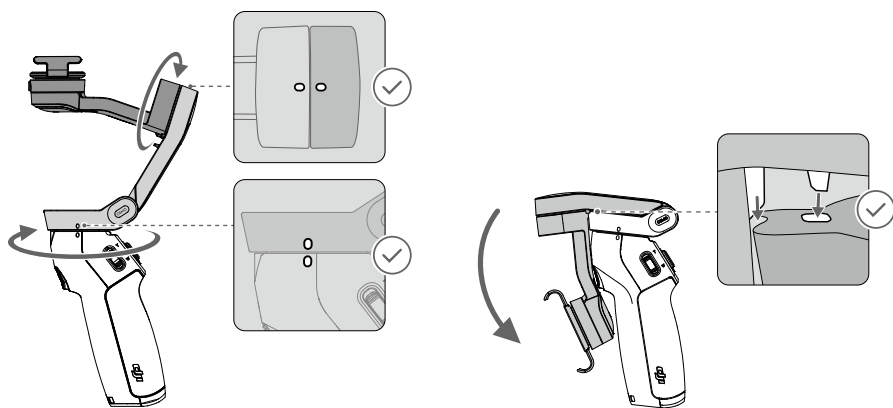

Specifications

Name	DJI OM 4
Model	OK100
Dimensions	Unfolded: 276×120×104 mm Folded: 163×100×47 mm
Weight	390 g (gimbal) 32.6 g (magnetic phone clamp) 11.4 g (magnetic ring holder)
Power Consumption	1.2 W (steady and balanced status)
Mechanical Range	Pan: -161.2° to 172° Roll: -136.7° to 198° Tilt: -106.5° to 235.5°
Max Controllable Speed	120°/s
Compatible Phones	Using Magnetic Phone Clamp and Ring Holder: Weight: 230±60 g Using Magnetic Phone Clamp: Diagonal: ≤ 196 mm (or ≤ 7.72 in) Thickness: 6.9-10 mm Width: 67-84 mm
Wireless Mode	Bluetooth Low Energy 5.0
Transmission Power (EIRP)	≤4 dbm
Operating Frequency	2.400-2.4835 GHz
Battery Type	18650 Li-ion
Capacity	2450 mAh
Energy	17.64 Wh
Voltage	7.2 V
Charging Temperature	5° to 40° C (41° to 104° F)
Operating Temperature	0° to 40° C (32° to 104° F)
Charging Time	2.5 hours (Measured with a 10W charger in the environment temperature of 25° C)
Operating Time	15 hours (Under ideal conditions with the gimbal fully balanced)

This content is subject to change.

**Download the latest version from
www.dji.com/om-4/downloads**

OSMO is a trademark of DJI OSMO.
Copyright © 2020 DJI OSMO All Rights Reserved.